

THIS DRAWING IS ISSUED BY STANTON BONNA CONCRETE LIMITED SUBJECT TO THE CONDITIONS THAT IT IS NOT COPIED EITHER IN WHOLE OR IN PART OR DISCLOSED TO THIRD PARTIES UNLESS PRIOR WRITTEN AUTHORISATION IS GIVEN BY STANTON BONNA CONCRETE LIMITED. PREVIOUS VERSIONS OF THIS DRAWING SHOULD BE STAMPED SUPERSEDED OR DESTROYED DO NOT SCALE THIS DRAWING - IF IN DOUBT ASK

REV	DESCRIPTION	DATE	BY	CK'D
0	INITIAL ISSUE	20/05/2015	MM	HMM
A	CHANGES THE SHEET AND NOTE	09/04/2018	MMA	
B	LID DETAIL 100 WAS 90, 150 WAS 130 UPDATE TEMPLATE, AND ISSUE	07/12/2018	MM	BB

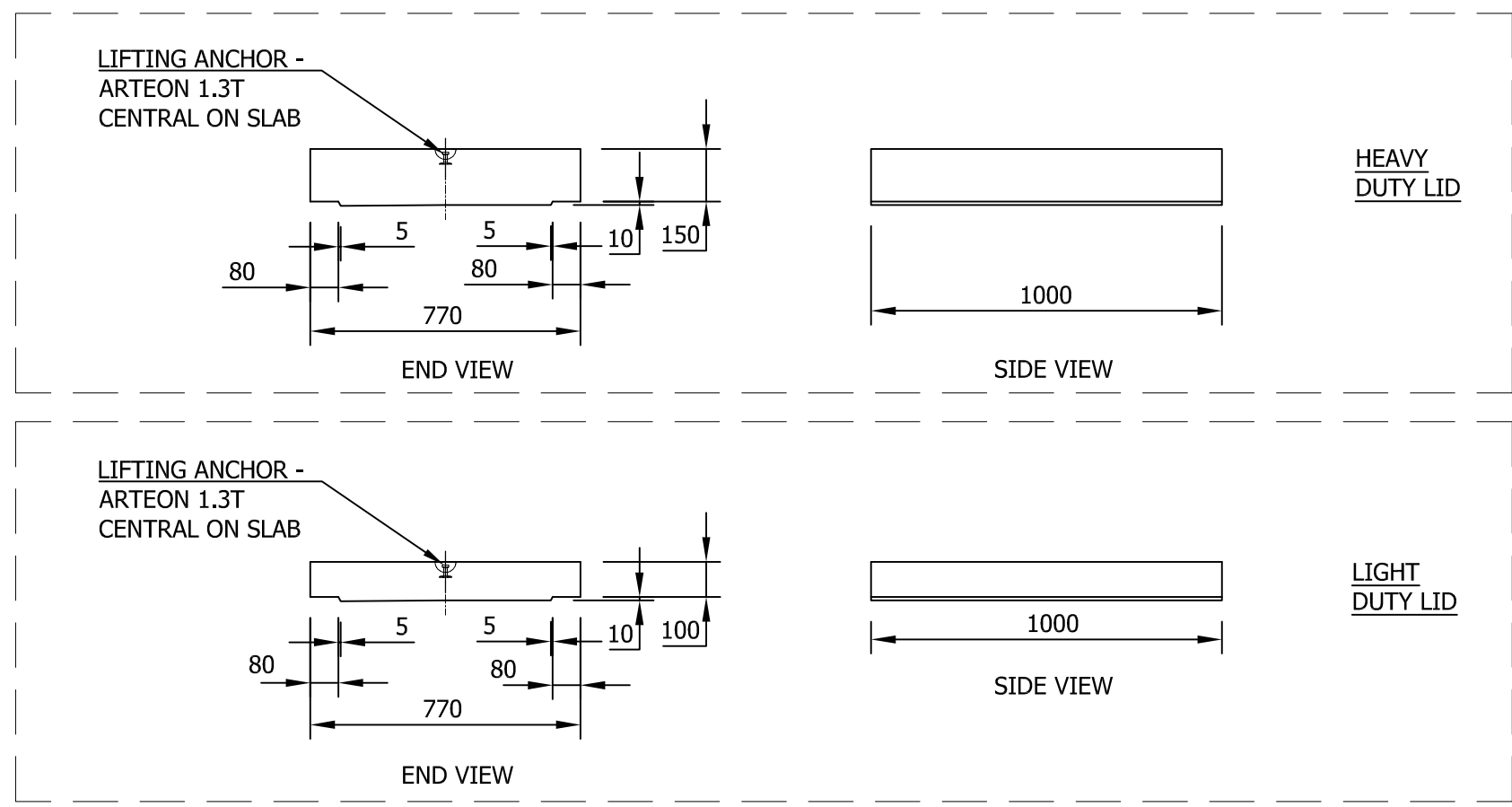

- A. TROUGH WEIGHT - 778kg PER UNIT
LIGHT DUTY LID WEIGHT - 173kg EACH.
HEAVY DUTY LID WEIGHT - 231kg EACH.
- B. HEAVY DUTY LIDS TO WITHSTAND WHEEL LOADS NOT EXCEEDING 11 TONNE
- C. LIGHT DUTY LIDS ARE DESIGNED FOR PEDESTRIAN AND DOMESTIC CAR PARKING LOADS ONLY - NOT TO BE USED IN HIGHWAYS OR COMMERCIAL VEHICLE ENVIROMENTS.
- D. PLEASE NOTE - A RUBBER OR FOAM CONFORMANCE LAYER BETWEEN TROUGH AND COVERS ARE RECOMMENDED WHERE UNITS ARE SUBJECT TO VEHICULAR LOADS.

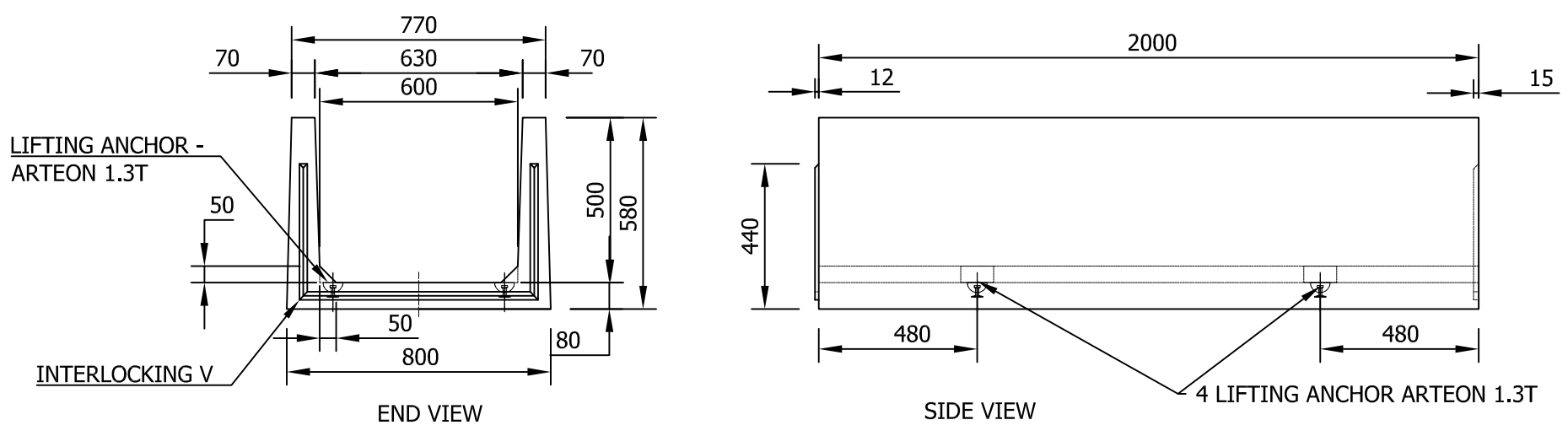

StantonBonna
 Littlewell Lane, Stanton-by-Dale, Ilkeston, Derbyshire. DE7 4QW
 TEL: 0115 944 1448 FAX: 0115 944 1466
 WEB: www.stanton-bonna.co.uk

Project	Drawn by MM / MMA	Checked by BB	Date 07/12/2018	Sheet size A3	Scale 1:20
Drawing Set Title TROUGH WITH LID SIZE 600 WIDE x 500 DEEP	Weight (Kg) SEE ABOVE	Nav Code -	Status PRODUCTION		
Sheet Description REF 225	Projection 	Dwg No. C2768 TROUGHS-27	Rev. B		