

Socket view

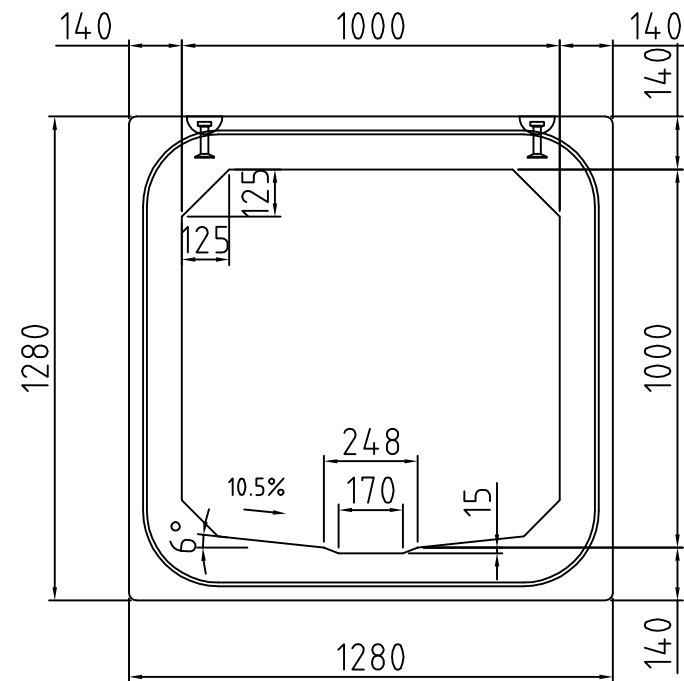

Longitudinal section

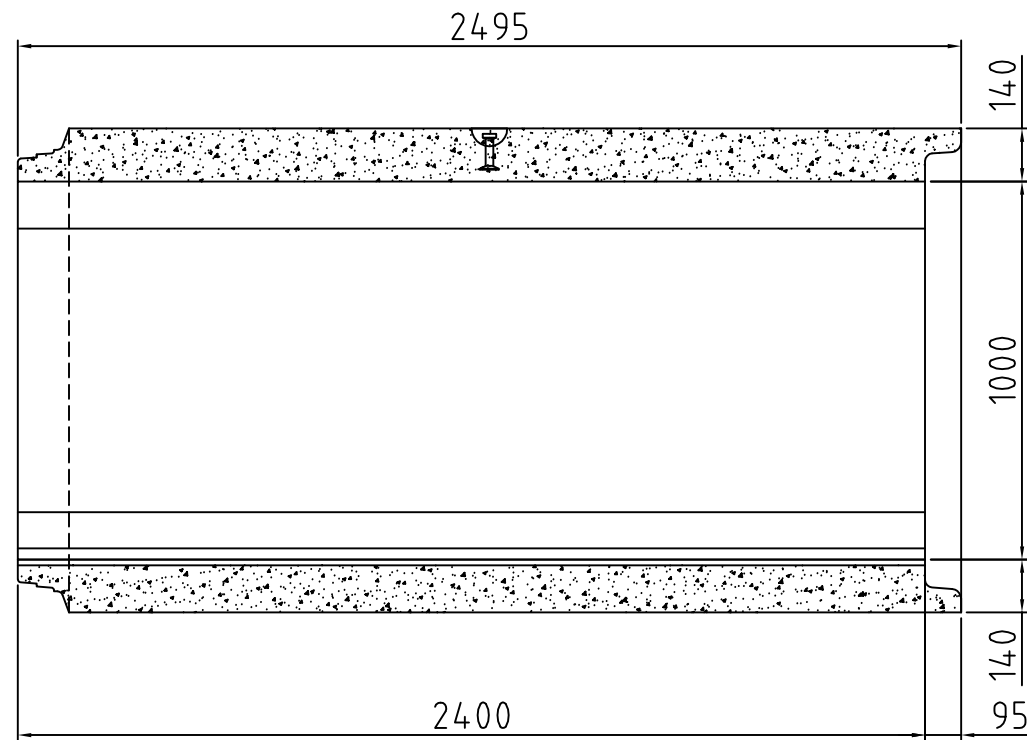

Top view

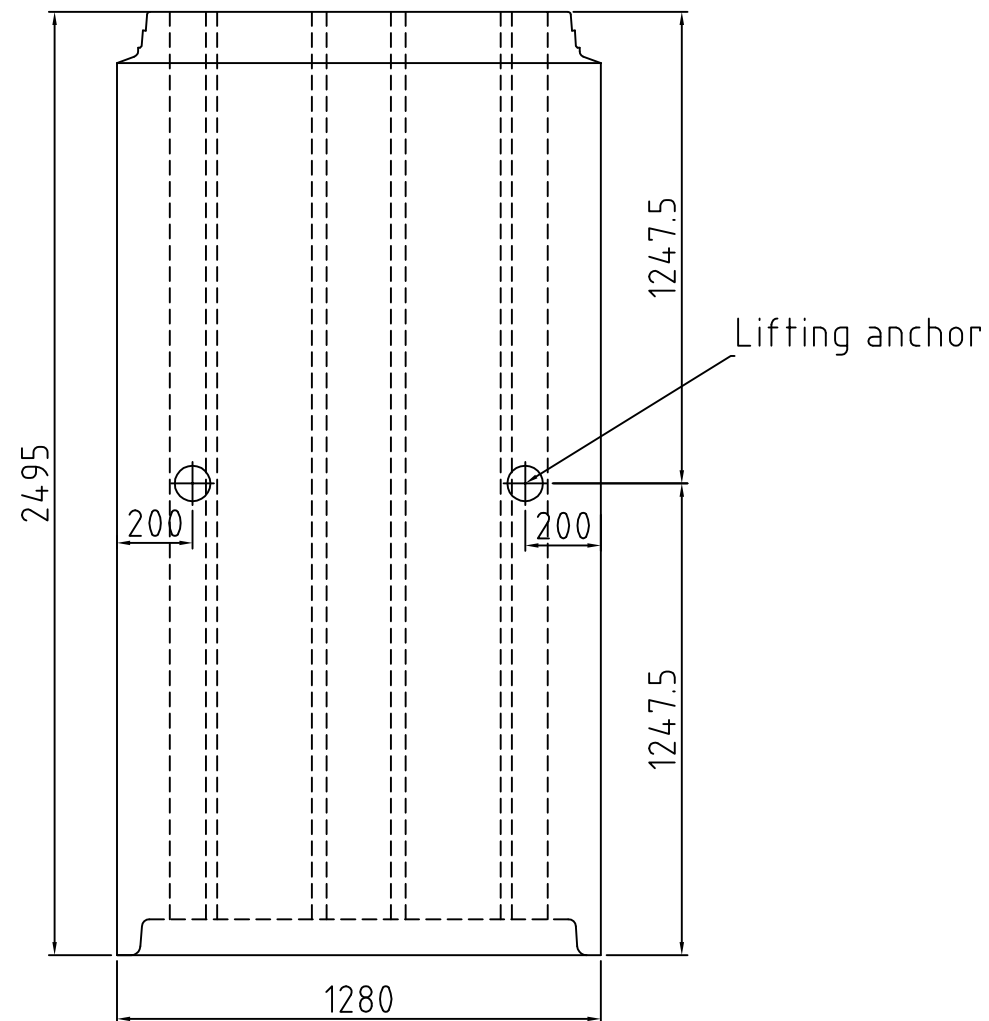

Joint section

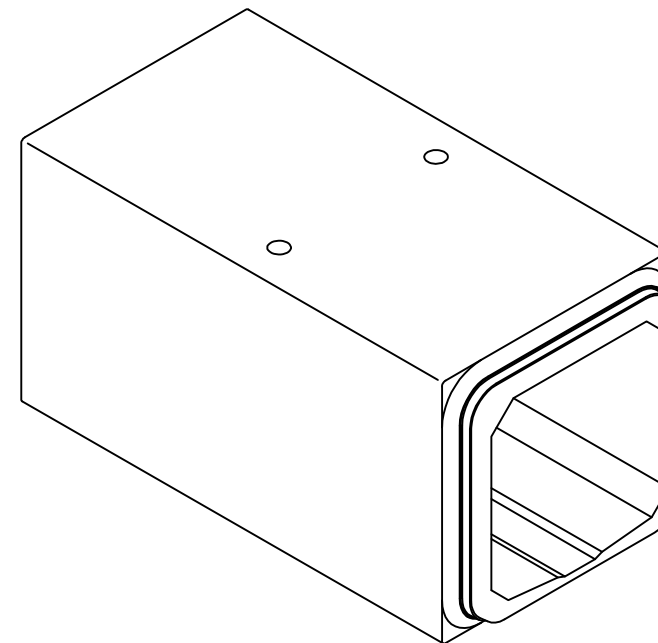
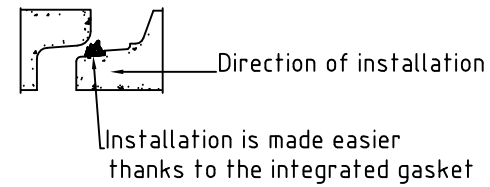

CUSTOMER APPROVAL

APPROVED

DATE

QUOTATION No.

ORDER No.

NOTE :-

1. Concrete class, durability class and nominal cover are defined in the calculation note.
2. The design loading is also defined in the calculation note.
3. Angle of Chain at Lifter <math>< 30^\circ</math> from Vertical, unit to be lifted using a Static Crane. For more details, refer to the installation instructions NT450 and NT451.
4. Position of the lifting points might be slightly adjusted to suit the reinforcement
5. Approximate UNIT WEIGHT = 4.00t

DESCRIPTION

AQUACULVERT
1000 x 1000

StantonBonna

DRAWN	NC
DATE	20/01/2016
CHKD	
DWG No.	AQCU0001