

DO NOT SCALE

COPY RIGHT AND DESIGN RIGHT

THIS DRG IS THE EXCLUSIVE PROPERTY OF STANTON BONNA CONCRETE LTD. AND IS CONFIDENTIAL AND MUST NOT BE REPRODUCED OR DISCLOSED TO A THIRD PARTY WITHOUT WRITTEN CONSENT. IT MUST BE USED ONLY FOR THE PURPOSE FOR WHICH IT HAS BEEN ISSUED AND IS RETURNABLE ON REQUEST

MACHINING SYMBOLS

	ISO	Ra
ROUGH MACHINE	N10	12.5µm
MEDIUM MACHINE	N8	3.2µm
FINE MACHINE	N6	0.8µm
GRIND MACHINE	N5	0.4µm

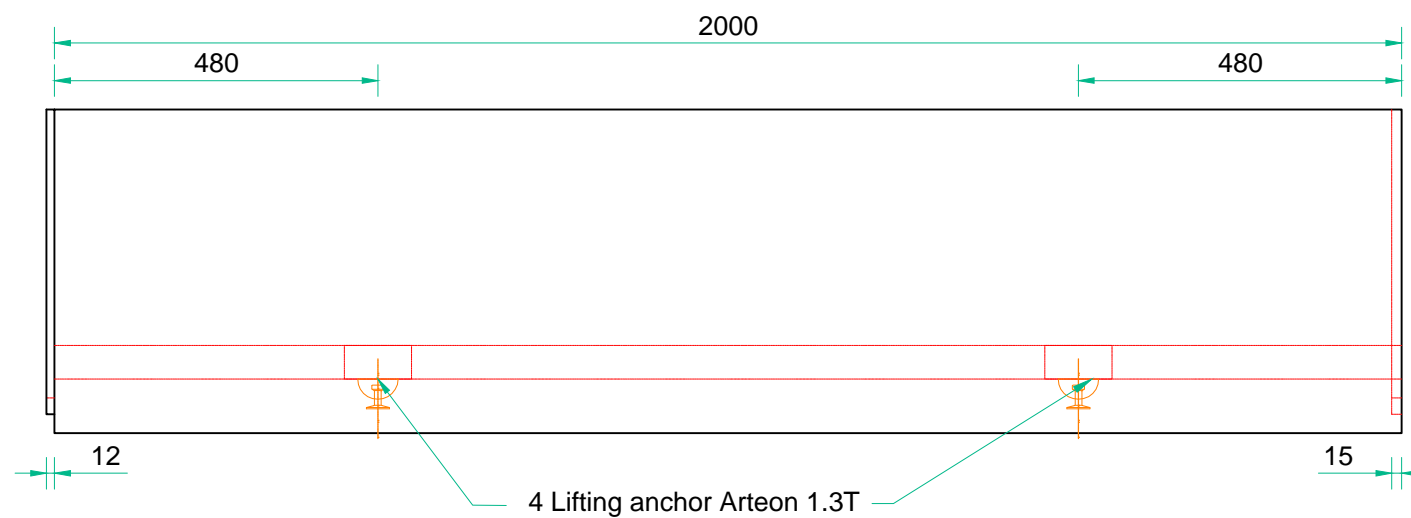
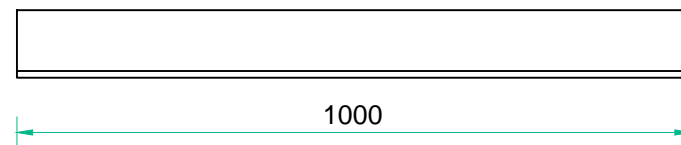
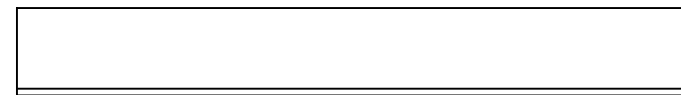
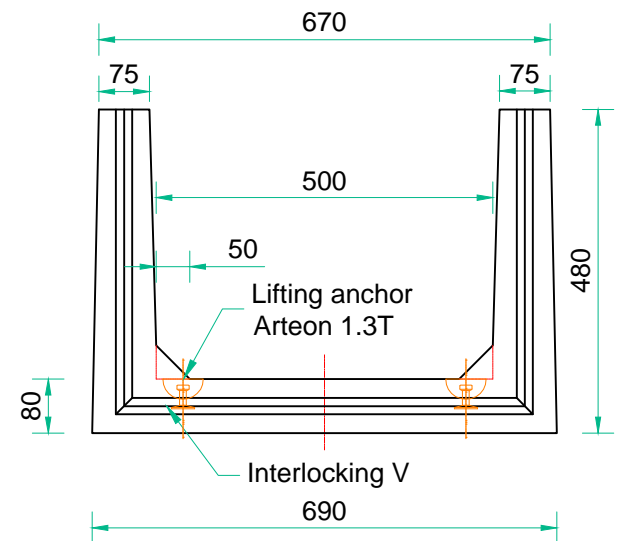
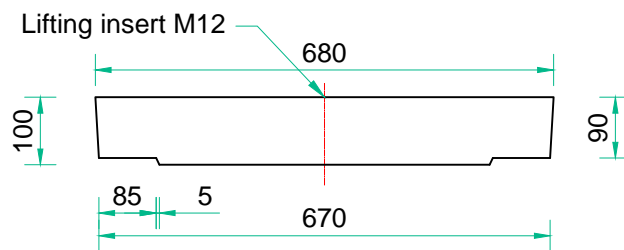
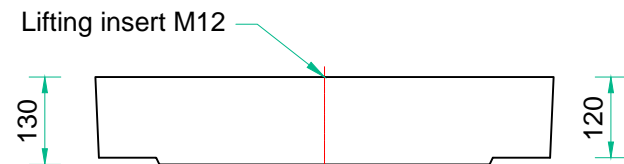

Stanton Bonna

TITLE

TROUGH with LID
size 500 Wide x 400 Deep
B-S Ref 231

Trough Weight - 624kg per unit
Standard Lid Weight - 172kg each.
Heavy duty Lid Weight - 205kg each
Troughs Designed and manufactured to BS EN 1433,
Load Classification D400, - Heavy Duty Lids to
withstand Wheel Loads not exceeding 11 tonne.

Please Note - A Rubber or Foam Conformance layer between trough and covers are recommended where units are subject to Heavy Vehicular Loads.

THIS DRAWING WAS PRODUCED USING AUTOCAD AND SHOULD ON NO ACCOUNT BE AMENDED BY HAND

STANTON BONNA CONCRETE LTD.
Littlewell Lane, Stanton-by-Dale,
Ilkeston, Derbyshire. DE7 4QW
TEL: 0115 944 1448 FAX: 0115 944 1466

SCALE	HMM
DRAWN	M MANNERS
DATE	26/05/2015

DRG. No. CDO/ C / 2751

REV No.	0
---------	---

REV	DATE	ZONE	ALTD	CKD	APPD	ALTERATIONS	REV	DATE	ZONE	ALTD	CKD	APPD	ALTERATIONS
							00						INITIAL ISSUE
													ALTERATIONS

DO NOT SCALE

COPY RIGHT
AND
DESIGN RIGHT

THIS DRG IS THE EXCLUSIVE PROPERTY OF STANTON BONNA CONCRETE LTD. AND IS CONFIDENTIAL AND MUST NOT BE REPRODUCED OR DISCLOSED TO A THIRD PARTY WITHOUT WRITTEN CONSENT. IT MUST BE USED ONLY FOR THE PURPOSE FOR WHICH IT HAS BEEN ISSUED AND IS RETURNABLE ON REQUEST

MACHINING SYMBOLS		
	ISO	Ra
ROUGH MACHINE	N10	12.5µm
MEDIUM MACHINE	N8	3.2µm
FINE MACHINE	N6	0.8µm
GRIND MACHINE	N5	0.4µm

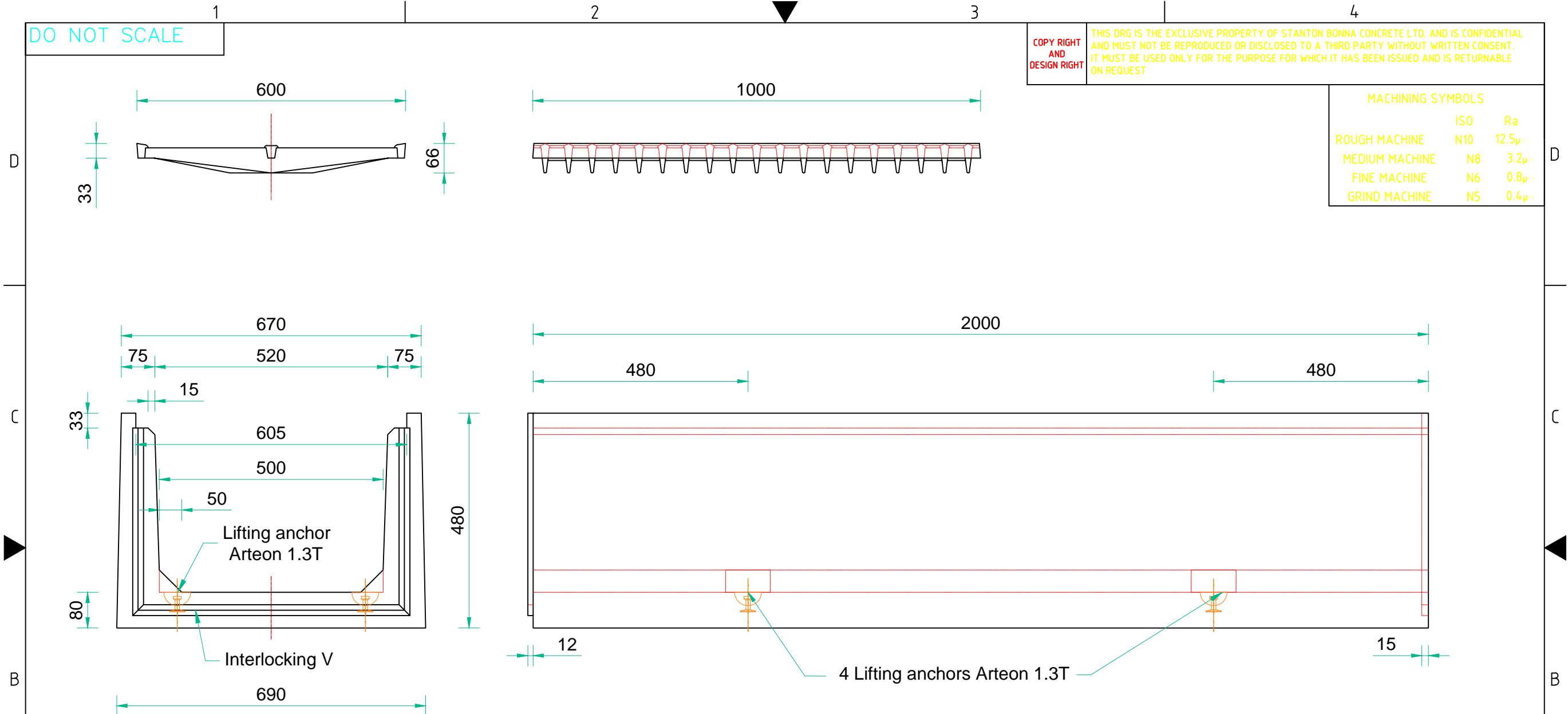

Trough Weight - 624kg per unit
Standard Lid Weight - 172kg each.
Heavy duty Lid Weight - 205kg each
Troughs Designed and manufactured to BS EN 1433,
Load Classification D400, - Heavy Duty Lids to
withstand Wheel Loads not exceeding 11 tonne.

Please Note - A Rubber or Foam Conformance layer between trough and covers are recommended where units are subject to Heavy Vehicular Loads.

THIS DRAWING WAS PRODUCED USING AUTOCAD AND SHOULD ON NO ACCOUNT BE AMENDED BY HAND

REV	DATE	ZONE	ALTD	CKD	APPD	ALTERATIONS	REV	DATE	ZONE	ALTD	CKD	APPD	ALTERATIONS
							00						INITIAL ISSUE
													ALTERATIONS

Stanton Bonna
TITLE

TROUGH with Steel Grating Drainage LID
size 500 Wide x 400 Deep
B-S Ref 230

STANTON BONNA CONCRETE LTD.
Littlewell Lane, Stanton-by-Dale,
Ilkeston, Derbyshire. DE7 4QW
TEL: 0115 944 1448 FAX: 0115 944 1466

SCALE	HMM
DRAWN	M MANNERS
DATE	26/05/2015

DRG. No. CDO/ C / 2751

REV No.	0
---------	---

ORIGINAL FRAME SIZE (INCL. BORDER) 594 x 420 A2