

T 0115 944 1448
F 0115 944 1466
E info@stanton-bonna.co.uk
W www.stanton-bonna.co.uk

Perforated Drainage Troughs – Narrow

Narrow precast concrete perforated drainage troughs are a modular system for trackside drainage applications. They are particularly suited to railway tunnels where limited construction widths are permitted.

Pedestrian Loading

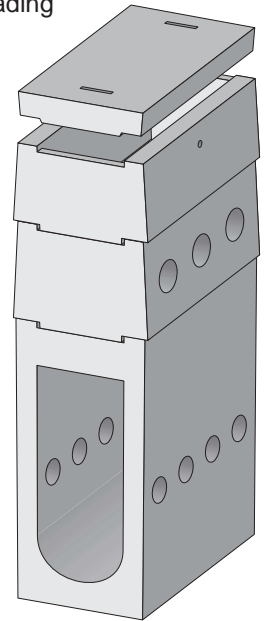

■ Cover

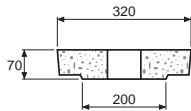

■ Riser H20

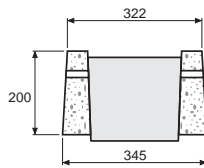

■ Riser H25

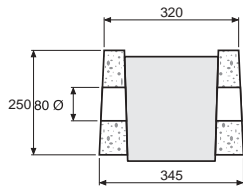

■ Trough H37

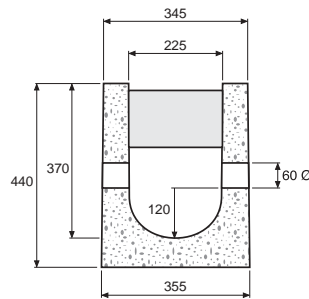

■ Trough H65

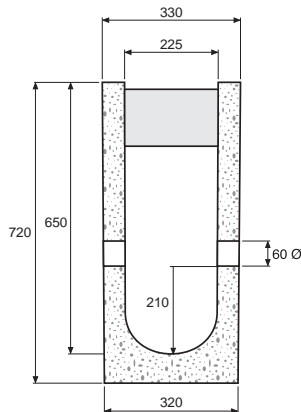

Perforated Drainage Troughs Data

Type	Component	Length m	Weight kg
Narrow Cover	Cover	0.75	33
Riser H20	Riser	0.75	55
Riser H25	Riser	0.75	65
Trough H37	Trough	0.75	160
Trough H65	Trough	0.75	197

T 0115 944 1448
F 0115 944 1466
E info@stanton-bonna.co.uk
W www.stanton-bonna.co.uk

Perforated Drainage Troughs – Narrow

Narrow precast concrete perforated drainage troughs are a modular system for trackside drainage applications. They are particularly suited to railway tunnels where limited construction widths are permitted.

Pedestrian Loading

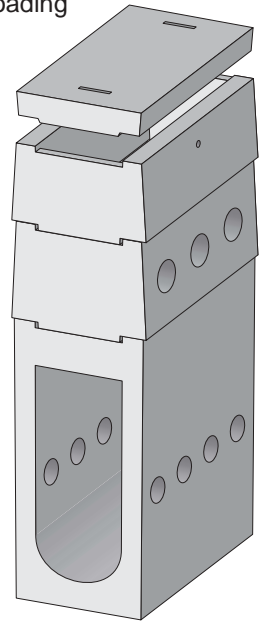

■ Trough H73

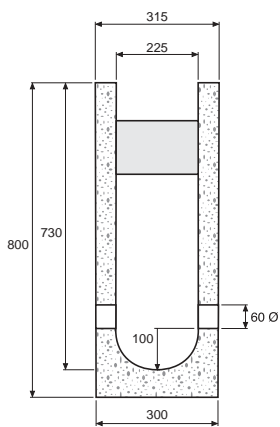

■ Trough H81

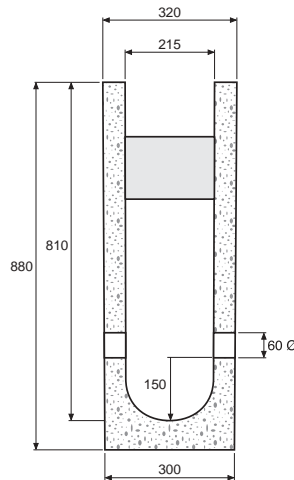

■ Trough H86

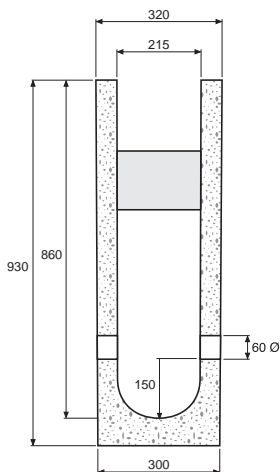

■ Trough H96

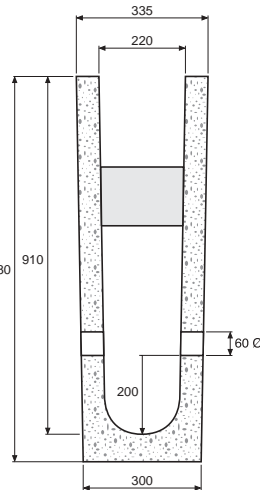

■ Trough H37

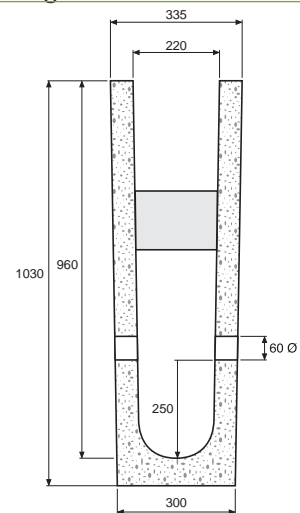

Perforated Drainage Troughs Data

Type	Component	Length m	Weight kg
Trough H73	Trough	0.75	225
Trough H81	Trough	0.75	252
Trough H86	Trough	0.75	262
Trough H91	Trough	0.75	272
Trough H96	Trough	0.75	282